

# COMBIVERT

## F4-F



**GB** INSTRUCTION MANUAL

Control Circuit

OFF4.0EB-K120



Read Instruction manual part 1 first!





<b>1.</b>	<b>Operating Specifications .....</b>	<b>GB 4</b>
1.1	Application .....	GB 5
1.2	Moving or Rotating Parts .....	GB 5
1.3	High Operating Temperatures.....	GB 5
1.4	Connection Instructions.....	GB 5
1.5	Operating Instructions .....	GB 6
1.6	Interference Protection of Electric Systems .....	GB 7
1.7	Interference Protection of the Frequency Inverter .....	GB 7
<b>2.</b>	<b>Connection.....</b>	<b>GB 8</b>
2.1	Summary.....	GB 8
2.2	Terminal X2 .....	GB 9
2.3	Parameter Interface .....	GB 11
2.4	Connection X4 Incremental Encoder .....	GB 12
2.5	Connection X5 Option .....	GB 13
<b>3.</b>	<b>Operation of the Unit.....</b>	<b>GB 14</b>
3.1	Keyboard .....	GB 14
3.2.	Parameter Summary .....	GB 15
<b>4.</b>	<b>Parameter Description .....</b>	<b>GB 16</b>
<b>5.</b>	<b>Drive-Mode.....</b>	<b>GB 36</b>
5.1	Adjustment Possibilities .....	GB 36
5.2	Condition .....	GB 36
5.3	Display and Keyboard .....	GB 36
5.4	Set Value Display / Set Value Presetting .....	GB 36
5.5	Rotation Presetting.....	GB 37
5.6	Start / Stop / RUN.....	GB 37
<b>6.</b>	<b>Error Diagnosis .....</b>	<b>GB 38</b>
<b>7.</b>	<b>Start-up.....</b>	<b>GB 40</b>
<b>8.</b>	<b>Short Manual.....</b>	<b>GB 42</b>
<b>9.</b>	<b>Password .....</b>	<b>GB 43</b>

# 1. Operating Specifications

This manual

- is valid for the frequency inverter **KEB COMBIVERT F4-F**
- must be made available to every user



***Before working with this unit you must familiarize yourself with it. Pay special attention to the safety and warning guides. Make sure to read 'Technical Documentation Part 1'!***



KEB COMBIVERT F4-F has very extensive programming options. To make the operation and start-up simpler for the user, a special operator level was created in which the most important parameters are found. However, if the parameters pre-defined by KEB are not sufficient for your application an **application manual** is available for a small fee.

- It includes:
- Creating an individual operator level
  - Listing and description of other parameters

The pictograms used in this manual mean:



**Danger  
Warning  
Caution**

Used when the life or health of the user is exposed to danger or when considerable damage to property can occur.



**Attention**

Must be observed!  
Special instructions for a safe and trouble-free operation.



**Information**

Assistance, Tip

### 1.1 Application

The frequency inverter **KEB COMBIVERT F4-F** is a drive component, which is intended for installation in electrical systems or machines. The frequency inverter is exclusively for stepless speed control/regulation of three-phase asynchronous motors. The operation of other electrical consumers is not permitted and can lead to the destruction of the unit.

### 1.2 Moving or Rotating Parts

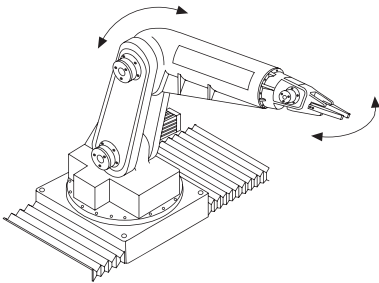

- Motor shaft
- Feed axis and parts connected to it



**Prior to any work on the machine (e.g. exchange of tools), disconnect it and secure against unintended restart!**



**Safely secure movement range of machine during operation! Danger of injury!**

### 1.3 High Operating Temperatures

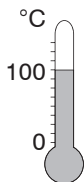

- Housing of the motor
- Braking resistors



**Motor housing and braking resistor can attain very high temperatures! Danger of injury!**

### 1.4 Connection Instructions

A trouble-free and safe operation of the frequency inverter is only guaranteed when the following connection instructions are observed.

**When deviated from, malfunctions and damages may occur in isolated cases.**

- The frequency inverter **KEB COMBIVERT** is only designed for a stationary connection.
- Do not interchange power cables and motor lines.
- Install control and power lines separately (min. 10 cm distance).

# 1. Operating Specifications

- Only connect control lines to switching elements and setting devices (relay, switch, potentiometer), that are suitable for extra-low voltages.
- Use shielded/twisted control lines. Connect the shield only single-sided to PE of the frequency inverter.
- Use shielded motor cables. Connect shield to the PE and extensively connect to motor housing.
- Earth frequency inverter very well: star-shaped earthing, avoid earth loops, shortest connection to main earthing terminal.



**The connections on the terminal strip and encoder inputs are safely isolated in accordance with VDE 0100. The person who installs the system / machine must make sure that the existing or newly wired circuit meets the VDE requirements.**

## 1.5 Operating Instructions



**To avoid damages to the inverter as well as material damages and injuries to persons, observe the following instructions:**

- Install an isolating switch between the voltage supply and inverter, so that **KEB COMBIVERT** can shut off independently.
- Frequent switching between mains and inverter is not permitted!
- Switching between motor and inverter during operation is prohibited!
- The **KEB COMBIVERT** is to be operated under suitable conditions (see Ambient Conditions in Part 2).
- When changing the programming of a frequency inverter (deviation from factory setting) check it once more before start up. ***!Wrong setting can lead to unintended behaviour of the drive!***
- Should a malfunction or a defect occur on the KEB COMBIVERT, in spite of keeping to the connection and operating instructions, it can lead to undefined operating conditions. Consequently the actuation of software-type protective measures like e.g. limit switch, the correct performance of a brake or the correct reaction to setpoint value settings is not guaranteed.
- The protection of a plant only through software protective functions is not sufficient, it is absolutely necessary to install external protective measures that are independent from the KEB COMBIVERT.

### 1.6 Interference Protection of Electric Systems

The frequency inverter **KEB COMBIVERT** transmits waves of high frequency. To reduce arising interference pulses, that may effect electric systems in the vicinity of the frequency inverter, do the following:

- Install the frequency inverter in metal housing.
- Shield motor cables.  
The shield must be connected to PE of the frequency inverter and to the housing of the motor (connect extensive shield). The shielding shall not be used as protective earthing. Only an uninterrupted shield beginning as close as possible to the frequency inverter or motor ensures a safe function of the shielding.
- Good earthing (metal-powder tape or 10 mm<sup>2</sup> earth lead)
- Use radio interference suppression filters.

### 1.7 Interference Protection of the Frequency Inverter



The control and power inputs of the frequency inverter are protected against interferences.

**For more operational reliability and additional protection against malfunctions following these measures:**

- Use of mains filter, when the mains voltage is affected by the connection of large consumers (reactive-power compensation equipment, HF-furnaces etc.)
- Protective wiring of inductive consumers (solenoid valves, relays, electromagnets) with RC elements or similar devices to absorb the energy released when the unit is switched off.
- Install wires, as described in the connection directions, to avoid inductive and capacitive coupling of interference pulses. Paired-twisted cables protect against inductive parasitic voltages, shielding provides protection against capacitive parasitic voltages. Optimal protection is achieved with twisted and shielded cables when signal and power lines are installed separately.

## 2. Connection

### 2.1 Summary Housing Sizes D - E

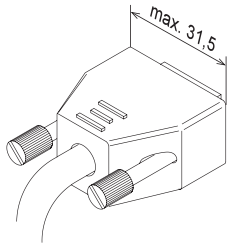

Observe the maximal width of connectors for X4 and X5.

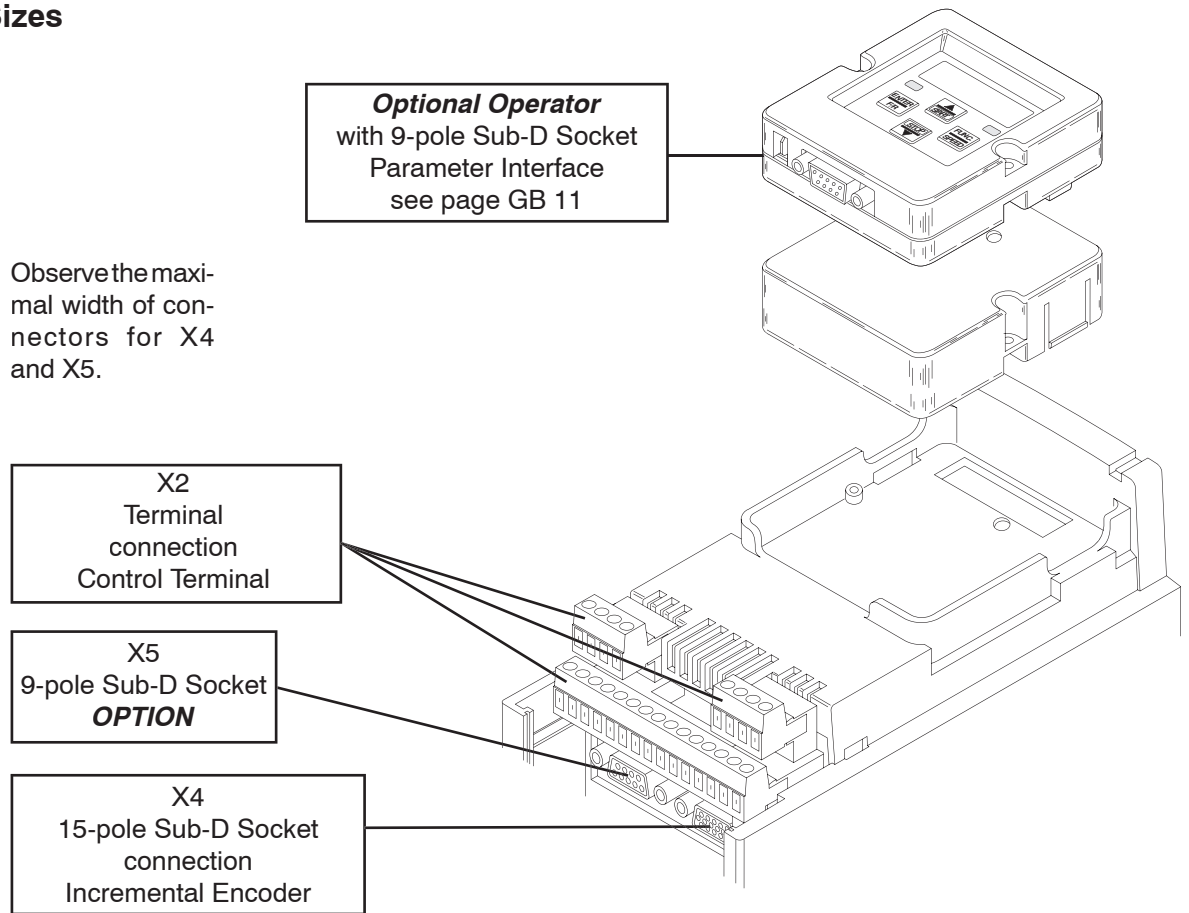

### Housing Sizes G - L

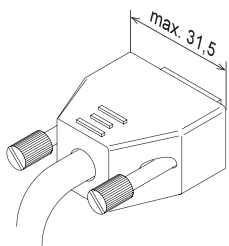

Observe the maximal width of connectors for X4 and X5.

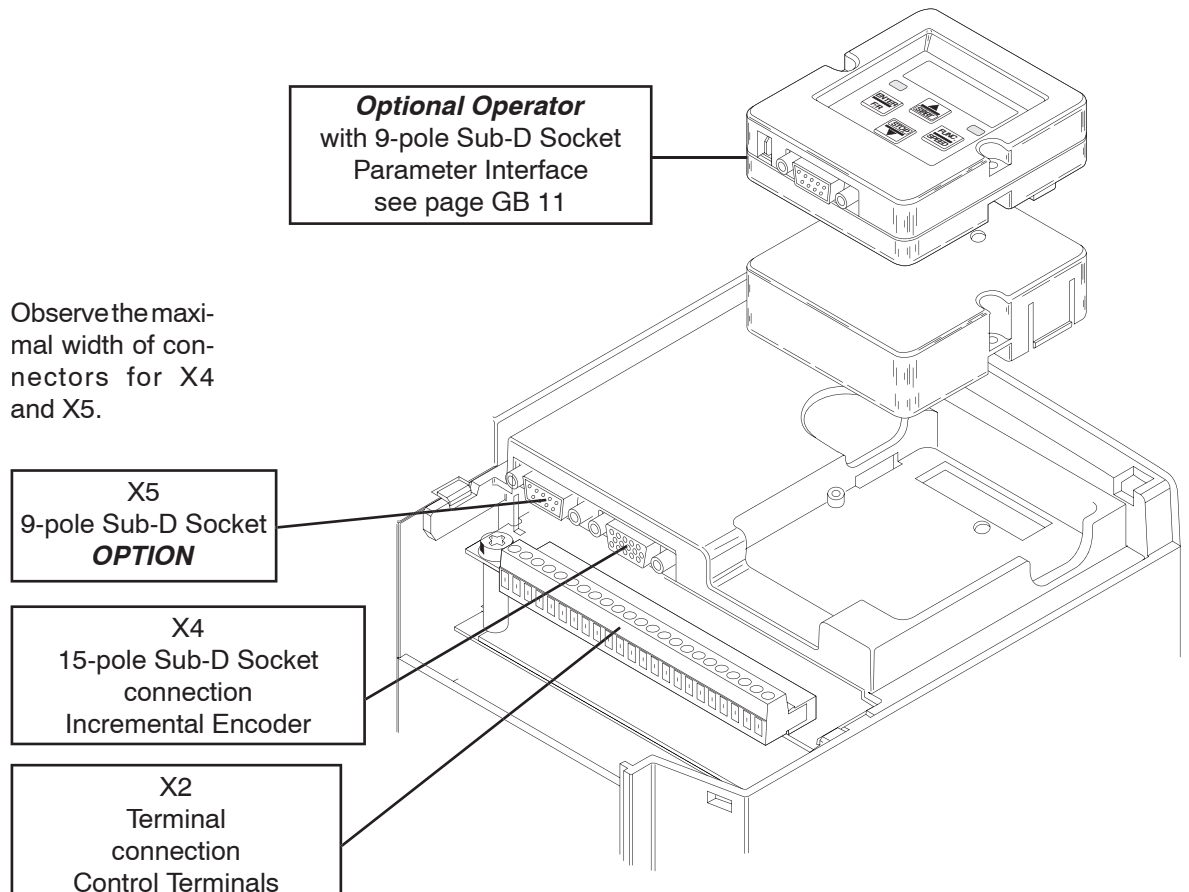



2.2. Terminal X2

Digital In- / Outputs

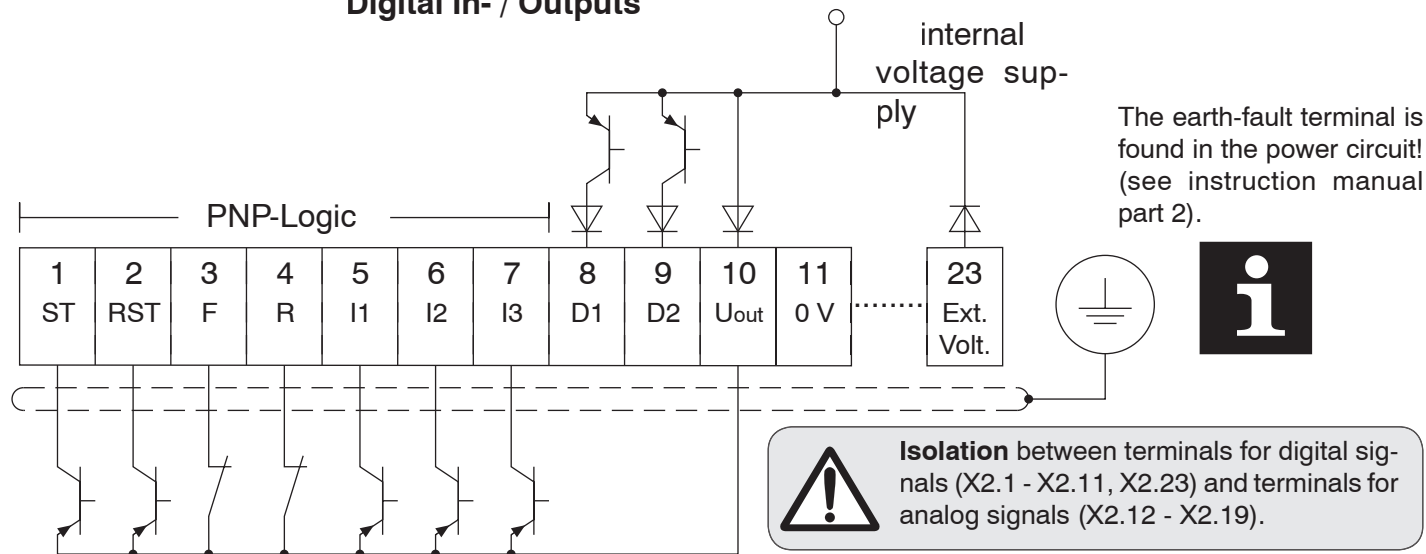

Terminal	Name	Function	
1	ST	Control release	<b>Digital Inputs</b> Noise immunity: 2 kV logic 1: ± 12...30 V Internal input resistor: approx. 2,7 kΩ PNP-Logic * The function must be activated with <b>CP.35</b> . If the unit is defective there is no guarantee that the software protective function will work.
2	RST	Reset	
3	F	Software limit switch forward / *1 forward direction of rotation	
4	R	Software limit switch forward / *1 reverse direction of rotation	
5	I1	Input for jogging speed forward see also parameter CP.11	
6	I2	Input for jogging speed reverse see also parameter CP.11	
7	I3	Input for external fault stopping mode see also parameter CP.15	
8	D1	digital output signal 1 see also parameter CP.21	programmable PNP - transistor outputs 14...30V / max. 20 mA (per Output)
9	D2	digital output signal 2 see also parameter CP.22	
10	Uout	+ 18 V Voltage output	Voltage supply supplied from the inverter for digital inputs and outputs <b>Uout:</b> 14...30V (depending on power circuit and load) <b>Iout:</b> max. 60 mA
11	0 V	Mass for Uout und digital I/Os	
23	Ext. Volt.	External power supply of control card	+ 24 (+/- 25%) external voltage input Ground: 0V (terminal X2.11) (dependent on power circuit / refer to Instruction Manual Part 2)

## 2. Connection

### 2.2. Terminal X2

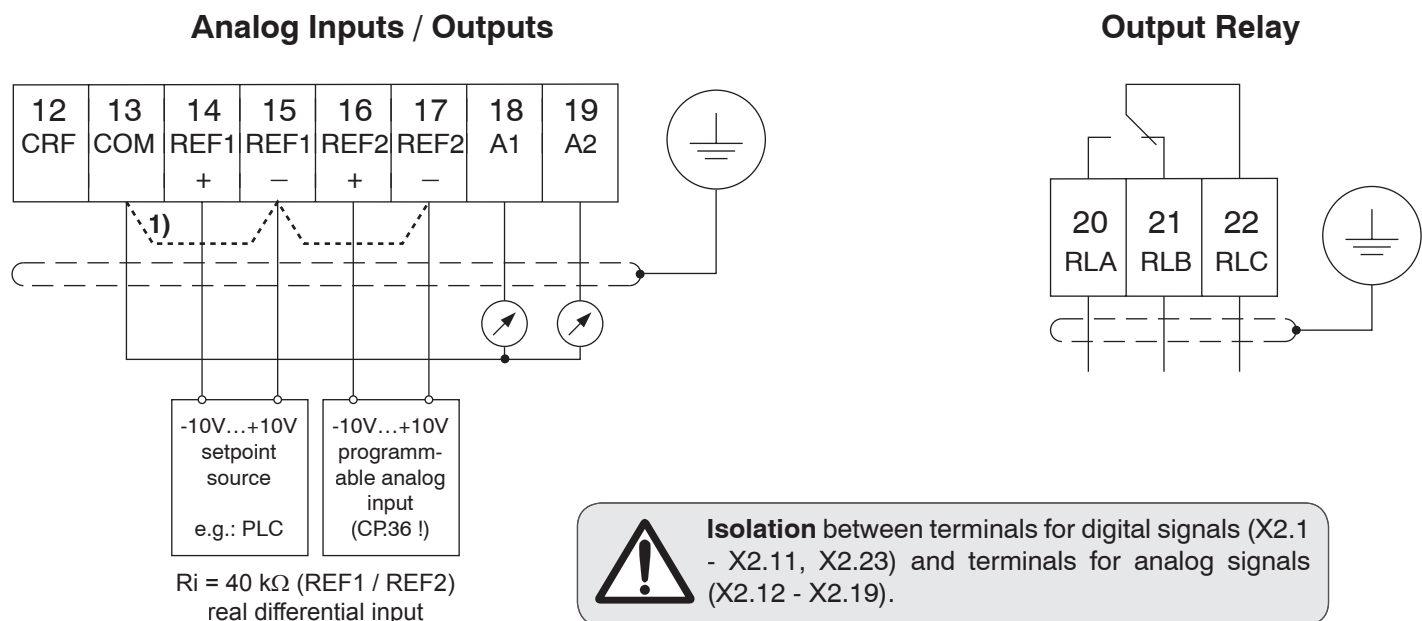

**1)** differential input with internal ground (COM)  
 $R_i = 24\text{ k}\Omega$  (REF1 / REF2)

Terminal	Name	Function	
12	CRF	+10 V reference voltage	+10V (+/- 3%) ; max. 4 mA
13	COM	Mass for analog I/Os	Lies on the same potential as the supply voltage for incremental encoder ( sub-D-socket X4 )
14	REF 1 +	analog setpoint input	differential voltage input - 10 V... + 10 V / resolution: +/- 11 Bit  $R_i = 24\text{ k}\Omega / 40\text{ k}\Omega$ (see wiring diagram)  smoothing time: 1 ms deceleration time: 1...3 ms
15	REF 1 -	see also parameter CP.16 + CP.17	
16	REF 2 +	programmable analog input	
17	REF 2 -	see also parameter CP.36	
18	A1	programmable analog output see also parameter CP.18 + CP.19	-10V...+10V / resolution: +/- 9 Bit $R_i = 100\ \Omega$ conditionally short-circuit proof ( <1 min )
19	A2	Output of the actual speed see also parameter CP.20	
20	RLA	Output relay:	30 VDC / 1 A
21	RLB	RLA / RLC : standard operating state	
22	RLC	RLB / RLC : POWER OFF / fault	

**2.3. Parameter Interface**  
*Operator*  
*only optional*

An operator is a necessary accessory for local operation of the inverter COMBIVERT F4. To prevent maloperation, the inverter must be brought into the **nOp** status (control release terminal X2.1) before it is connected/disconnected.

The operator is available in several versions:

**Digital-Operator**  
**Part No. 00.F4.010-2009**

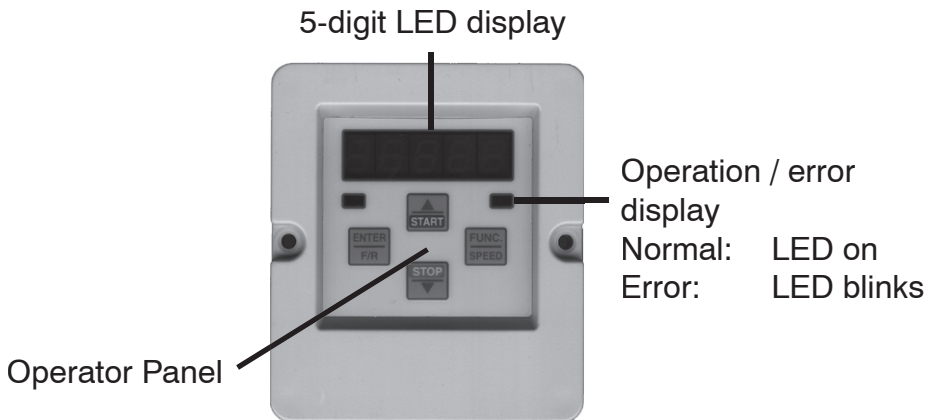

**Interface-Operator**  
**Part No. 00.F4.010-1009**

An isolated interface RS232/RS485 is additionally integrated into the Interface Operator.

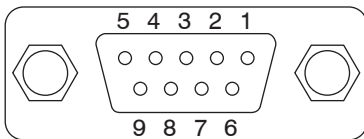

PIN	RS485	Signal	Description
1	—	—	reserved
2	—	TxD	transmission data / RS232
3	—	RxD	receiving data / RS232
4	A'	RxD-A	receiving data A / RS485
5	B'	RxD-B	receiving data B / RS485
6	—	VP	supply voltage plus +5V ( $I_{max}=10\text{ mA}$ )
7	C/C'	DGND	Data ground
8	A	TxD-A	transmission data A / RS485
9	B	TxD-B	transmission data B / RS485

Information about other operators available from KEB!

## 2. Connection

### 2.4 Connection X4 Incremental Encoder

The incremental encoder of the motor is connected onto the 15-pole sub-D-socket.

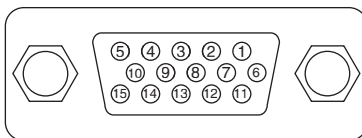

The 14...18 V supply voltage (PIN 11) at X4 can be loaded with maximal 85 mA. Alternatively the +5,2 V supply voltage can be loaded with 250 mA.

Signal	PIN-No.
+14...+18 V <sup>1)</sup>	11
~ +5,2 V	12
GND	13
A +	8
A -	3
B +	9
B -	4
N +	15
N -	14
shield	housing

<sup>1)</sup> dependent on power circuit



**The plug may only be connected / disconnected when the inverter and supply voltage are disconnected!**

#### Input Wiring

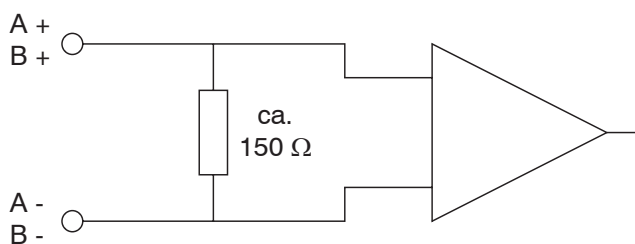

**Encoder Specifications:** 1- Encoder voltage: ~ 5,2 V

2- Encoder line number: 256 - 10000 Inc. (recommended: 2500 Inc. for applications with a maximum speed < 4500 rpm)

cut-off frequency of the Interface: 200 kHz

Observe cut-off frequency of the encoder:

$$f_{\text{limit}} > \frac{\text{increments} \cdot n_{\text{max}}}{60} \text{ Hz}$$

**3- Output signals:**

**3.1- Rectangular**

*Signal*

Two square-wave pulses that are electrically by 90° out of phase and their inverse signals (TTL-push-pull signals / RS422-conform)

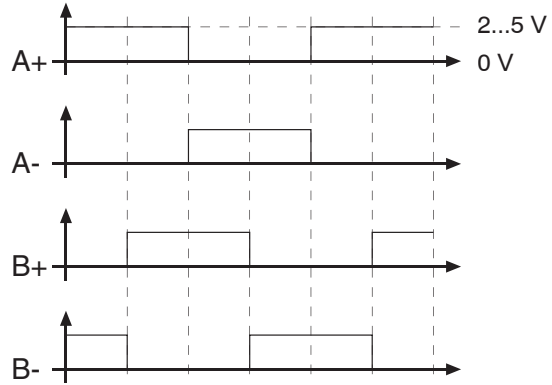

**3.2- sinusoidal**

*1 Vss-signals*

Two square-wave pulses that are electrically by 90° out of phase and their inverse signals

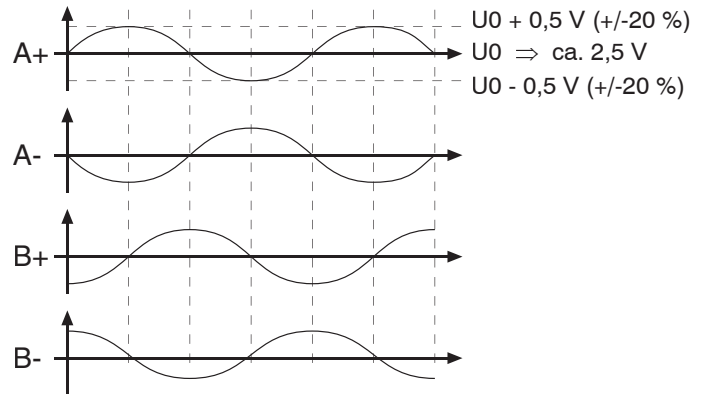

**4- line length:**

At maximum the encoder line may be so long that the sum of the *voltage drop on the encoder line* and the min. encoder supply voltage is less than +5,2 V.

$$[ (I_{Encoder} \cdot R_{Line}) + U_{Encoder (min)} ] < +5,2 V$$

**2.5 Connection X4 Option**

The 9-pole sub-D-socket is used for options.  
For Connection and Startup see Application Manual!

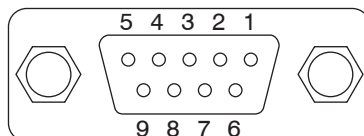

Signal	PIN-No.
- dependent on the option -	

## 3. Operation

### 3.1 Keyboard

When **KEB COMBIVERT F4** is started, the value of parameter CP.1 is displayed (actual speed display).

Use the **function-key** to change between parameter value and parameter number.



With **UP** (▲) and **DOWN** (▼) the parameter number, or with **changeable** parameters, the value is increased/decreased.

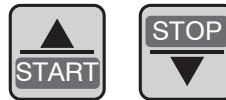

The adjusted value is not immediately accepted in the ENTER parameters. When this type of parameter is changed, a point appears behind the last digit. The adjusted parameter is accepted and permanently stored when **ENTER** is pressed (Point deleted).



If a disturbance occurs during operation, the actual display is overwritten with the error message. Press **ENTER** to reset the error message.



Use the **ENTER** key to reset the error message in the actual display. In the status display (CP.2) the error will still be shown. To reset the error yourself, remove the cause of the error and do a reset on terminal X2.2, or a power-on-reset.

### 3.2. Parameter Summary

Parameter Number	Parameter Description	Adjustment Range	Resolution	Factory Setting
CP.0	Password Input	0...9999	1	–
CP.1	Actual speed display	–	0,5 rpm	–
CP.2	Status display	–	–	–
CP.3	Apparent motor current	–	0,1 A	–
CP.4	Max. apparent motor current	–	0,1 A	–
CP.5	Actual torque display	–	0,1 Nm	–
CP.6	Speed reference display	–	0,5 rpm	–
CP.7	Acceleration time	0...320 s	0,01 s	2,0 s
CP.8	Deceleration time	0...320 s	0,01 s	2,0 s
CP.9	Torque limit	0...5 x M <sub>N</sub> Nm	0,1 Nm	dependent on size
CP.10	Maximum setpoint speed	0...6000 rpm	0,5 rpm	2100 rpm
CP.11	Jogging speed	0...6000 rpm	0,5 rpm	100 rpm
CP.12	P-factor speed controller	0...65535	1	400
CP.13	I-factor speed controller	0...65535	1	200
CP.14	Encoder 1 (inc/r)	256...10000	1	2500
CP.15	Behaviour at external fault	0...6	1	0
CP.16	Offset REF 1	-100...+100 %	0,1 %	0 %
CP.17	Zero point hysteresis REF 1	0...10 %	0,1 %	0,2 %
CP.18	Function output A1	0...6	1	1
CP.19	Gain output A1	-20...+20	0,01	1
CP.20	Gain output A2	-20...+20	0,01	1
CP.21	Output condition D1	0...20	1	20
CP.22	Output condition D2	0...20	1	18
CP.23	Torque level D1	0...50 Nm	0,1 Nm	0 Nm
CP.24	Speed level D2	0...9999,5 rpm	0,5 rpm	0 rpm
CP.25	Rated motor power	0,01...75 kW	0,01 kW	dependent on size
CP.26	Rated motor speed	100...6000 rpm	1 rpm	dependent on size
CP.27	Rated motor current	0,1...50 A	0,1 A	dependent on size
CP.28	Rated motor frequency	20...300 Hz	1 Hz	dependent on size
CP.29	Rated motor cos (Phi)	0,05...1	0,01	dependent on size
CP.30	Rated motor voltage	100...400 V	1 V	400 V
CP.31	Load motor dependent parameter	0...2	1	0
CP.32	Speed control on/off	0...1	1	0
CP.33	Boost	0...25 %	0,1 %	2 %
CP.34	Change encoder 1 rotation	0...1	1	0
CP.35	Reaction to limit switch	0...6	1	6
CP.36	Aux function	0...5	1	0

<sup>1)</sup> Resolution means the program internal resolution of parameters.

The accuracy of the detection / calculation of the parameter values may be worse than the resolution.

<sup>2)</sup> See table for parameter values that are dependent on the size (page GB 35)!



Due to the calculation / measuring accuracies, tolerances with the current and torque displays as well as with the switching levels and limitations, must be taken into consideration. The given tolerances (see parameter description) refer to the respective maximum values with the dimensioning KEB COMBIVERT: Motor = 1:1.

**Dependent on the data from the motor manufacturer, larger tolerances at the torque displays are possible, due to the usual variations in the machine parameters and temperature drifts.**

## 4. Parameter Description

CP 0

### Password Input

The inverters are delivered from the factory without password protection, i.e. all changeable parameters can be altered. After parameterization the unit can be barred against unauthorized access. The adjusted mode is stored.

The passwords are found on page GB 43 !

### Locking CP-Parameters

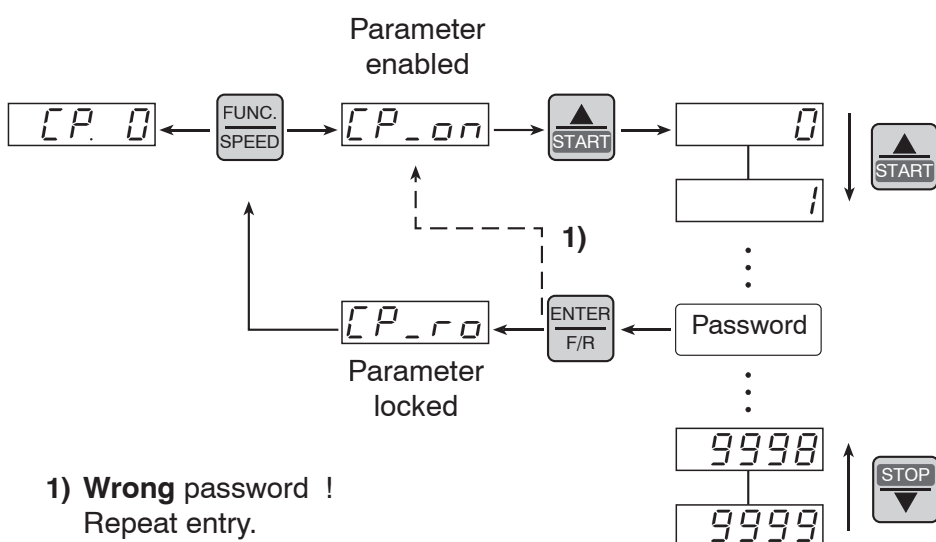

### Enabling CP-Parameters

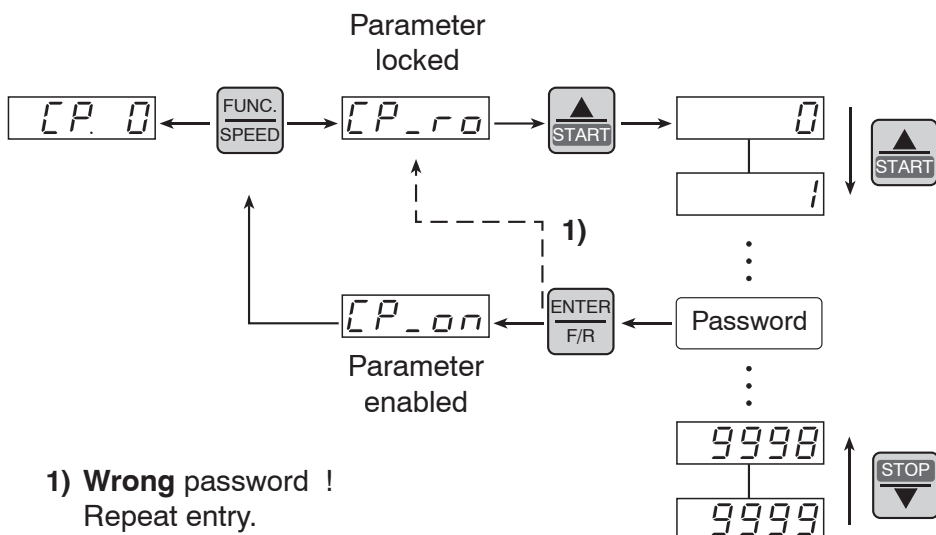



**Actual Speed Display**

Display of the actual motor speed (incremental encoder).

*For a correct display value, observe the adjustment of encoder 1 (inc/r) (CP.14) and the change encoder 1 rotation (CP.34) of the incremental encoder!*

Example:

Display	Direction of Rotation	Actual Motor Speed	Resolution of Display
	"forward"	1837,5 rpm	0,5 rpm
	"reverse"	1837,0 rpm or 1837,5 rpm	1 rpm <small>(The internal resolution of the speed is 0.5 rpm)</small>

**Status Display**

Shows the actual operating state of the inverter. Possible displays and their meaning:

**no Operation**

- Control release (terminal X2.1) not activated
- Modulation off
- Output voltage = 0 V/drive uncontrolled

**Forward Acceleration**

- Drive accelerates forward

**Forward deceleration**

- Drive decelerates forward

**reverse Acceleration**

- Drive accelerates in reverse

**reverse deceleration**

- Drive decelerates in reverse





**Forward constant**

- Drive runs with constant speed and forward

**reverse constant**

- Drive runs with constant speed and reverse

## 4. Parameter Description

		<b>Base-Block Time</b>	– The Base-Block-Time (motor suppression time) runs out. The power transistors are locked.
A b n o r m a l  S t o p p i n g		<b>external fault</b>	– The external fault is triggered (terminal X2.7). <b>The drive's response to external errors is adjusted in parameter CP.15.</b>
		<b>Prohibited rotation forward</b>	– Rotation release on terminal X2.3 is missing: Drive does not start with positive setpoint and/or decelerates until standstill. <b>See also parameter CP.35</b>
		<b>Prohibited rotation reverse</b>	– Rotation release on terminal X2.4 missing: Drive does not start with negative setpoint and/or decelerates until standstill. <b>See also parameter CP.35</b>



### Apparent Motor Current

Displays the actual apparent current in ampere.

Resolution: 0,1 A

max. tolerance: approx. ±10 %



### Max. Apparent Motor Current

Displays the maximum apparent motor current, which is measured during operation. The display is in ampere.

During operation, using **UP** (▲) or **DOWN** (▼) you can reset the peak value. The peak value is deleted when the unit is POWER OFF.

Resolution: 0,1 A

max. tolerance: approx. ±10 %



### Actual Torque Display

Displays the actual torque in newtonmeter.

Resolution: 0,1 Nm

max. tolerance: approx. ±30 % in base speed range

(In the field weakening range larger tolerances are possible.

also see reference on page GB 15)

**During open-loop operation (CP.32 = 0) value 0 is always shown.**

CP. 6

**Speed Reference Display**

Displays the speed reference at the output of the ramp generator in rpm.

When the modulation is switched off the setpoint 0 rpm is displayed.

Resolution: 0,5 rpm

positive speed: direction of rotation "forward"

negative speed: direction of rotation "reverse"

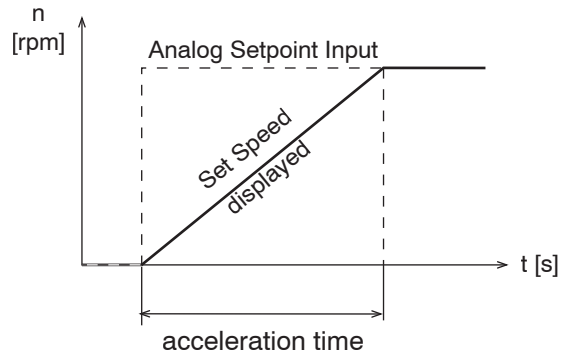

CP. 7

**Acceleration Time**

Defines the time needed to accelerate from 0 to 1000 rpm. The actual acceleration time is proportional to the speed change ( $\Delta n$ ).

Adjustment Range: 0...320 s

Resolution: 0,01 s

Factory setting: 2,0 s

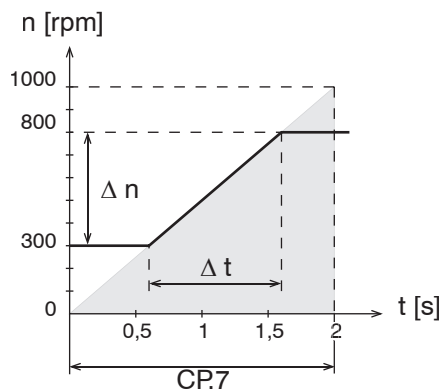

$\Delta n$  speed change  
 $\Delta t$  acceleration time for  $\Delta n$

$$CP.7 = \frac{\Delta t}{\Delta n} \times 1000 \text{ rpm}$$

Example:

The drive should accelerate from 300 rpm to 800 rpm in 1 s.

$$\Delta n = 800 \text{ rpm} - 300 \text{ rpm} = 500 \text{ rpm}$$

$$\Delta t = 1 \text{ s}$$

$$CP.7 = \frac{\Delta t}{\Delta n} \times 1000 \text{ rpm} = \frac{1 \text{ s}}{500 \text{ rpm}} \times 1000 \text{ rpm} = 2 \text{ s}$$

## 4. Parameter Description

CP. 8

### Deceleration Time

Defines the time needed to decelerate from 1000 to 0 rpm. The actual deceleration time is proportional to the speed change ( $\Delta n$ ).

*Adjustment Range:* 0...320 s

*Resolution:* 0,01 s

*Factory setting:* 2,0 s

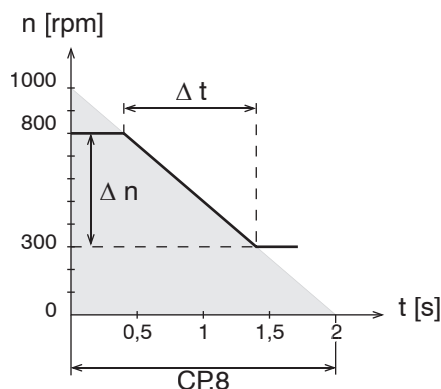

$\Delta n$  speed change  
 $\Delta t$  deceleration for  $\Delta n$

$$CP.8 = \frac{\Delta t}{\Delta n} \times 1000 \text{ rpm}$$

#### Example:

The drive should decelerate from 800 rpm to 300 rpm in 1 s.

$$\Delta n = 800 \text{ rpm} - 300 \text{ rpm} = 500 \text{ rpm}$$

$$\Delta t = 1 \text{ s}$$

$$CP.8 = \frac{\Delta t}{\Delta n} \times 1000 \text{ rpm} = \frac{1 \text{ s}}{500 \text{ rpm}} \times 1000 \text{ rpm} = 2 \text{ s}$$

CP. 9

### Torque Limit

Adjusts the maximum permissible torque of the drive. The parameter can be influenced by the analog torque limitation. **During open-loop operation (CP.32 = 0) this parameter has no function.**

*Adjustment Range:* 0...5 x  $M_N$  Nm

*Resolution:* 0,1 Nm

*Factory setting:* dependent on size

max. tolerance: approx.  $\pm 20\%$  in base speed range

(In the field weakening range larger tolerances are possible.

also see reference on page GB 15)

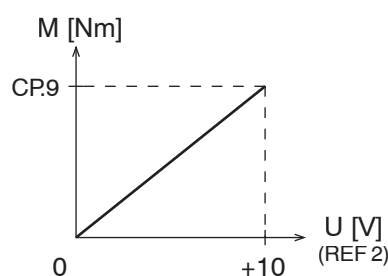

Analog Limiting  
 Terminals X2.16 / X2.17  
**! only when CP.36 = 5 !**



The maximum torque of the drive is limited by the following:

– *Dimensioning*      *KEB COMBIVERT – Motor*

If KEB COMIBVERT is dimensioned too small the necessary torque is automatically limited due to a motor current which is too low.

– *Programming the Motor Parameters CP.25 - CP.30*

Dependent on the adjusted motor data a speed-dependent limit curve (see below) is set. The value of the calculated maximum torque is automatically written in parameter CP.9

Parameter CP.31 (Load motor dependent parameter) activates the motor data and the respective limit curve.

See table on page GB 35 for the factory setting of the motor parameter!

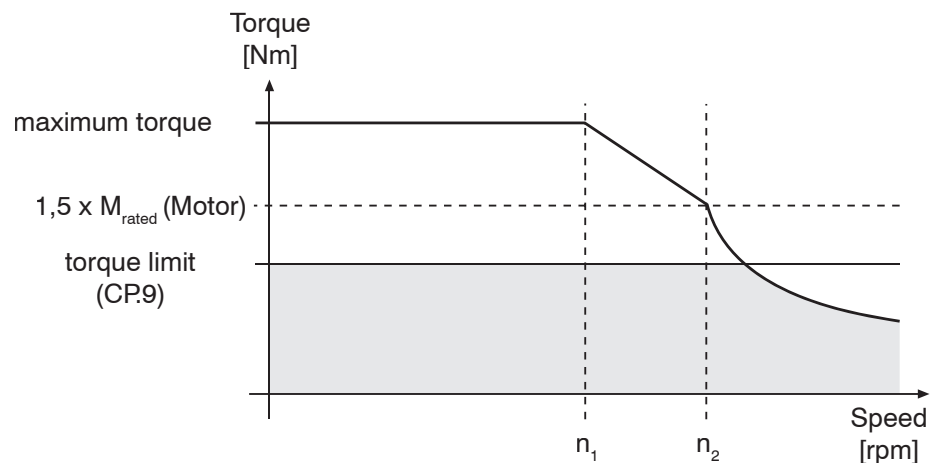

$$n_1 = 0,6 \times n_{fn} \times \frac{U_{rated}}{CP.30}$$

$$n_2 = 0,86 \times n_{fn} \times \frac{U_{rated}}{CP.30}$$

$n_{fn}$       *Nominal-Rotating Field Speed*

$U_{rated}$       *Inverter Rated Voltage*

$CP.30$       *Motor Rated Voltage*

## 4. Parameter Description

CP.10

### Maximum Setpoint Speed

Defines the maximum setpoint speed.

*Adjustment Range:* 0...6000 rpm

*Resolution:* 0,5 rpm

*Factory setting:* 2100 rpm

Analog setpoint  
[rpm]

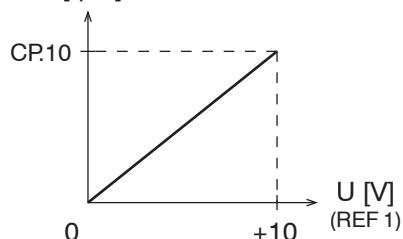

Analog setpoint presetting: REF  
1  
terminals X2.14 + X2.15

**! see also parameter CP.36 !**



**Only the reference speed is limited by this parameter. The actual speed can exceed this value because of control oscillations or a fault in the speed detection.**

CP.11

### Jog-Speed

Specifies a jogging speed (fixed speed), which can be activated by the digital inputs I1 (forward) or I2 (reverse). If both rotations are simultaneously preset, 'forward' has priority.

*Adjustment Range:* 0...6000 rpm

*Resolution:* 0,5 rpm

*Factory setting:* 100 rpm

#### **Function:**

- I1 or I2 active  $\Rightarrow$  The drive runs with an adjusted jogging speed.
  - The original direction of rotation, speed, acceleration and deceleration times do not have a function!
  - ACC and DEC times only have limited functions (see the following table)!
  - If the jogging speed entered is too high, the adjusted value is internally limited onto the maximum permissible motor speed!
  - The software limit switches (see CP.35) remain active!
- I1 and I2 not active  $\Rightarrow$  The drive runs with the analog reference speed.

Input I1 / I2	Speed Ratio	Acceleration/ Deceleration Performance
is activated	Actual speed dis. (CP.1) < Jogging speed (CP.11)	drive accelerates on the torque limit
is activated	Actual speed dis. (CP.1) > Jogging speed (CP.11)	drive accelerates in accord. with the adjusted ramp
is deactivated	Speed reference dis. (CP.6) < Jogging speed (CP.11)	drive decelerates on the torque limit
is deactivated	Speed reference dis. (CP.6) > Jogging speed (CP.11)	drive accelerates in accord. with the adjusted ramp

CP.12

**P-Factor Speed Controller**

Proportional factor of the speed controller.

Adjustment assistance found in chapter "Startup" page GB 40 / D 41.

*Adjustment Range:* 0...65535

*Resolution:* 1

*Factory setting:* 400

**! see also parameter CP.36 !**

CP.13

**I-Factor Speed Controller**

Integral factor of the speed controller.

Adjustment assistance found in chapter "Startup" page GB 40 / D 41.

*Adjustment Range:* 0...65535

*Resolution:* 1

*Factory setting:* 200

**! see also parameter CP.36 !**

CP.14

**Encoder 1 (inc/r)**

Adjusts the increments of the incremental encoder used. Check the set and actual speed displays during open-loop operation and compare.

The correct setting is: actual speed = set speed - slip

*Adjustment Range:* 256...10000

*Resolution:* 1

*Factory setting:* 2500

## 4. Parameter Description

CP.15

### Behaviour at External Fault

This parameter determines how the drive reacts to an external error (digital Input I3).

*Adjustment Range:* 0...6

*Resolution:* 1

*Factory setting:* 0

*Note:* **ENTER-Parameter**

Value	Error / Status message	Response of the drive
0	<b>E.EF</b>	modulation immediately switched off ! To restart remove error and <b>activate Reset !</b>
1	<b>A.EF</b>	quick stop / modulation switched off after speed 0 is reached ! To restart remove error and <b>activate Reset !</b>
2	<b>A.EF</b>	quick stop / holding torque at speed 0 ! To restart remove error and <b>activate Reset !</b>
3	<b>A.EF</b>	modulation immediately switched off ! <b>Automatic restart</b> , when error is no longer present !
4	<b>A.EF</b>	quick stop / modulation switched off after speed 0 is reached ! <b>Automatic restart</b> , when error is no longer present !
5	<b>A.EF</b>	quick stop / holding torque at speed 0 ! <b>Automatic restart</b> , when error is no longer present !
6	<b>none</b>	no effect on the drive ! <b>Fault is ignored !</b>



**Quick stop**



deceleration at the torque limit (CP.9)



CP.16

Offset REF 1

Makes it possible to shift the speed setpoint curve.

Adjustment Range: -100...+100 %

Resolution: 0,1 %

Factory setting: 0 %

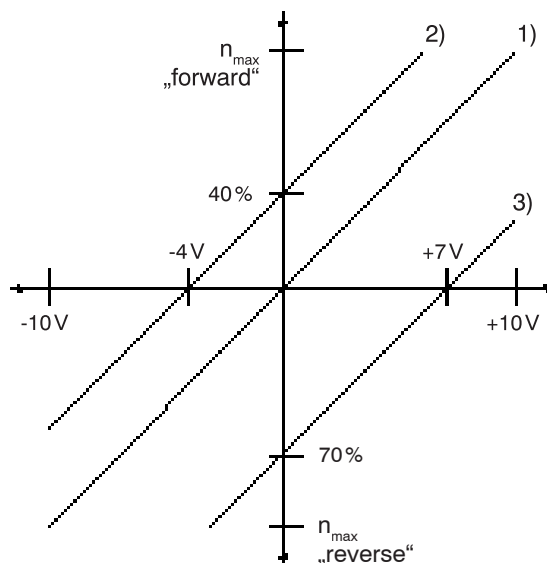

### Examples:

Curve 1: CP.16 = 0% (Standard adjustment)

0V = 0 rpm

Direction of rotation „forward“:  $n_{\max}$  is reached at +10V

Direction of rotation „reverse“:  $n_{\max}$  is reached at -10V

Curve 2: CP.16 = -40%

0V = -40 % of  $n_{\max}$  „forward“

Direction of rotation „forward“:  $n_{\max}$  is reached at 60% of +10V

Direction of rotation „reverse“: maximum 60% of  $n_{\max}$  possible

Curve 3: CP.16 = +70%

0V = 70 % of  $n_{\max}$  „reverse“

Direction of rotation „forward“: maximum 30% of  $n_{\max}$  possible

Direction of rotation „reverse“:  $n_{\max}$  is reached at 30% of -10V

## 4. Parameter Description

CP.17

### Zero Point Hysteresis REF 1

CP.17 adjusts a zero point hysteresis of the setpoint input REF1. Voltage fluctuations and ripple voltages near the zero point of the setpoint do not cause the motor to shift.

*Adjustment Range:* 0...10 %

*Resolution:* 0,1 %

*Factory setting:* 0 %

This function has a switching hysteresis of 50%. If the analog signal is larger than the adjusted hysteresis value (CP.17), then the analog value is active. If the analog signal goes below 50% of the adjusted hysteresis value ( $0.5 \times \text{CP.17}$ ), then the analog setpoint is set at 0.

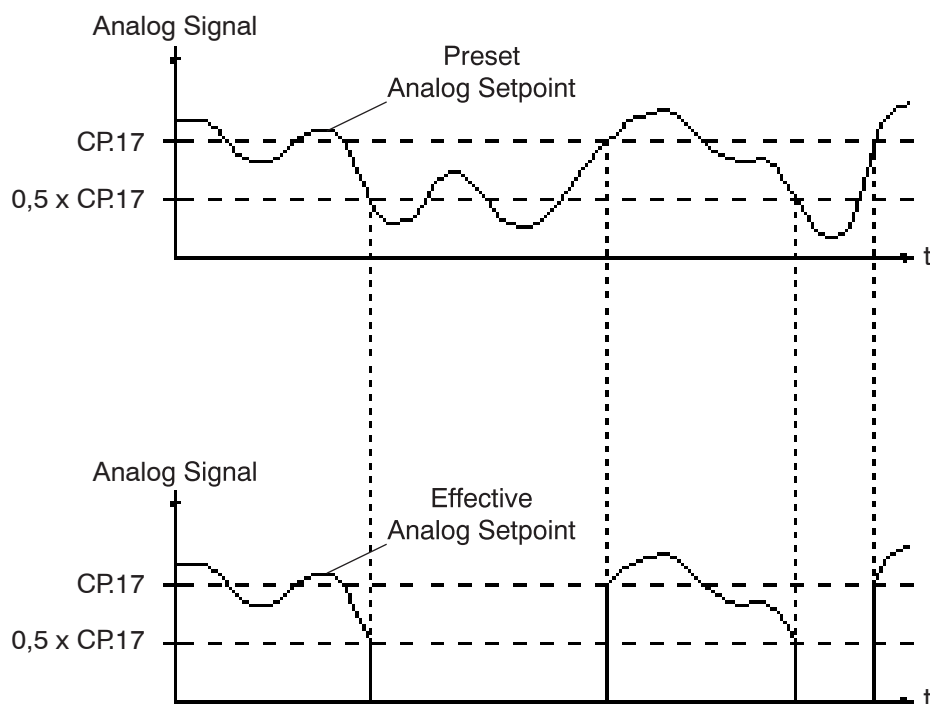

for CP.17 the  
following is valid:  
 $0...10\% \hat{=} 0...±1\text{ V}$

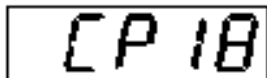

## Function Output A1

Defines which variable is displayed on analog output 1 (terminal X2.18).

*Adjustment Range:* 0...6

*Resolution:* 1

*Factory setting:* 2

*Note:* **ENTER-Parameter**

Value	Output Variable	Value Range when CP.19 = 1
0	Actual speed	$-2 \cdot n_{fn} \dots +2 \cdot n_{fn} \hat{=} -10V \dots +10V$
1	Motor apparent current	$0 \dots 2 \cdot I_{SN} \hat{=} 0 \dots +10V$
2	Actual torque	$-2 \cdot M_N \dots +2 \cdot M_N \hat{=} -10V \dots +10V$
3	DC-bus voltage	$0 \dots 1000 V \hat{=} 0 \dots +10V$
4	Speed reference (CP.6)	$-2 \cdot n_{fn} \dots +2 \cdot n_{fn} \hat{=} -10V \dots +10V$
5	Control difference (speed controller)	$-2 \cdot n_{fn} \dots +2 \cdot n_{fn} \hat{=} -10V \dots +10V$
6	Set torque	$-2 \cdot M_N \dots +2 \cdot M_N \hat{=} -10V \dots +10V$

$n_{fn}$ : Rated-Rotating Field Speed

$M_N$ : Rated Torque

$I_{SN}$ : Rated-Motor Apparent Current



During open-loop operation (CP.32 = 0) the analog output A1 has no function with the values 2,5, and 6.

## 4. Parameter Description

**CP.19**

### Gain Output A1

The parameter CP.19 specifies the gain of the analog output signal on output A1 (terminal X2.18).

*Adjustment Range:* -20...+20

*Resolution:* 0,01

*Factory setting:* 1

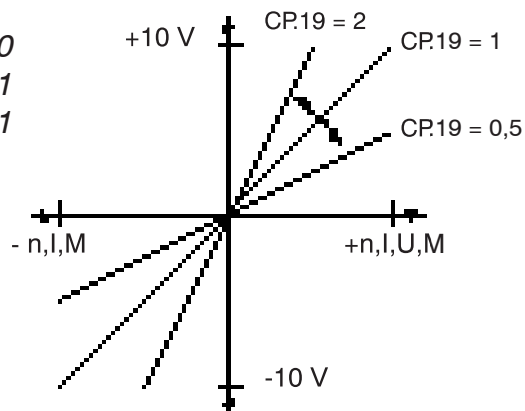

### Calculation example:

When  $1.5 \times M_{\text{rated}}$  +10 V should be measured on analog output A1.

$$\text{CP.19} = \frac{\text{value when gain is 1 (see CP.18)}}{\text{desired value at +10V}} = \frac{2 \times M_{\text{rated}}}{1.5 \times M_{\text{rated}}} = 1.33$$

**CP.20**

### Gain Output A2

Determines the gain of the analog output signal A2 (terminal X2.19). The analog output A2 specifies the actual speed of the motor.

*Adjustment Range:* -20...+20

*Resolution:* 0,01

*Factory setting:* 1

for gain 1  
the following is valid:  
 $\pm(2 \cdot n_m) \hat{=} \pm 10 \text{ V}$

$n_m$ : Rated-Rotating Field Speed

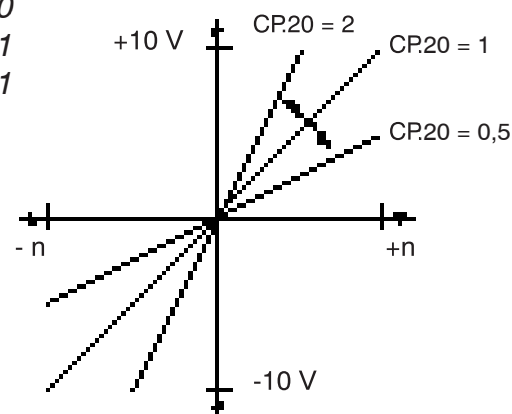

**See CP.19 for calculation example**

**CP.21**

### Output Condition OUT D1

Parameter CP.21 determines the output condition of digital output D1 (terminal X2.8). **! see table below !**

*Adjustment Range:* 0...28

*Resolution:* 1

*Factory setting:* 20

CP.22

### Output Condition OUT D2

Parameter CP.22 determines the output condition of digital output D2 (terminal X2.9). **! see table below !**

Adjustment Range: 0...28

Resolution: 1

Factory setting: 18

Value	D1 and D2 Switching conditions	
0	always inactive	
1	always active	
2	ready for operation; no malfunction (operating state: ready)	
3	ready for operation; control release (terminal X2.1) given;	
4	modulation enabled (operating state: run) abnormal operating state or error (status A.xx or E.xx)	
5	error (only status E.xx)	
6	- reserved -	
7	after the motor positive temperature coefficient is triggered	
8	after the motor positive temperature coefficient is triggered	
9	current controller restricted	
10	speed controller restricted	
11	any controller restricted	
12	drive accelerates	
13	drive decelerates	
14	drive runs with constant speed	
15	drive runs with constant speed > speed 0	
16	forward – not with noP, LS, Abnormal Stopping or error	
17	reverse – not with noP, LS, Abnormal Stopping or error	
	<b>only digital output D1</b>	<b>only digital output D2</b>
18	- reserved -	actual speed > speed level
19	- reserved -	- reserved -
20	torque > torque level <sup>1)</sup>	- reserved -
21	- reserved -	
22	- reserved -	
23	- reserved -	
24	overload prewarning: overload counter > 80 %	
25	overload prewarning: overload counter > 40 %	
26	prewarning: „heat sink temperature“	
27	- reserved -	speed reference displ. > speed level
28	- reserved -	system deviation > speed level <sup>1)</sup>
29	overload 2 - prewarning (refer to Instruction Manual Part 2)	
30	- reserved -	
31	- reserved -	
32	- reserved -	
33	error (only status E.xx)	

<sup>1)</sup> **Only during closed-loop operation (CP.32 = 1)!**



Hysteresis

of the torque level : 5% of  $M_N$  motor adjusted in the factory  
(see page GB 35)

of the speed level : 10 rpm

## 4. Parameter Description

CP.23

Torque Level output D1

Defines the torque level for the digital output D1.

*Adjustment Range:* 0...1000 Nm

*Resolution:* 0,1 Nm

*Factory setting:* 0 Nm

max. Tolerance approx.  $\pm 30\%$  in the base speed range  
(In the field weakening range larger tolerances are possible.  
also see reference on page GB 15)

**During open-loop operation (CP.32 = 0) the value for the motor torque is set at 0.**

CP.24

Speed Level output D2

Defines the speed level for the digital output D2.

*Adjustment Range:* 0...9999,5 rpm

*Resolution:* 0,5 rpm

*Factory setting:* 0 rpm

CP.25

Rated Motor Power

The rated motor power of the connected motor must be adjusted in CP.25.

*Adjustment Range:* 0,01...75 kW

*Resolution:* 0,01 kW

*Factory setting:* dependent on size

CP.26

Rated Motor Speed

The rated motor speed of the connected motor must be adjusted in CP.26.

*Adjustment Range:* 100...6000 rpm

*Resolution:* 1 rpm

*Factory setting:* dependent on size

CP.27

Rated Motor Current

The rated current of the connected motor must be adjusted in CP.27.

*Adjustment Range:* depend. on size

*Resolution:* 0,1 A

*Factory setting:* dependent on size

CP.28

Rated Motor Frequency

The rated frequency of the connected motor must be adjusted in CP.28.

*Adjustment Range:* 20...300 Hz

*Resolution:* 1 Hz

*Factory setting:* dependent on size



Rated Motor cos (Phi)

The rated power factor of the connected motor must be adjusted in CP.29.

*Adjustment Range:* 0,05...1

*Resolution:* 0,01

*Factory setting:* dependent on size

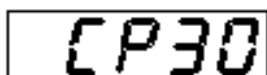

Rated Motor Voltage

The rated voltage of the connected motor must be adjusted in CP.30.

*Adjustment Range:* 100...500 V

*Resolution:* 1 V

*Factory setting:* 400 V

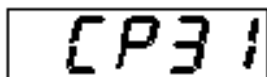

Load motor dependent parameter

The basic settings of the inverter correspond to the size of the unit and the respective motor (see table on page GB 35). If the motor data in CP.25...30 are changed, then CP.31 must be activated once. This re-adjusts the current controller, torque curve and torque limit. With this the torque limit is set at the value, that is maximally possible in the speed range (dependent on inverter rated current).

CP.31 = 1 : - The motor data is adapted.  
- The calculation of the voltage stabilization of the DC-link circuit is done at 400 V mains voltage.

CP.31 = 2 : - The motor data is adapted.  
- The frequency inverter measures the actual mains voltage and takes it as basis for the calculation of the voltage stabilization of the DC-link circuit. Thus the frequency inverter can be adapted to the various mains voltages of the different countries (e.g. USA with 460 V).

*Adjustment Range:* 0...2

*Resolution:* 1

*Werkseinstellung:* 0



**When control release is active the adjustment was not completed.  
„nco“ appears in the display!**

## 4. Parameter Description

CP32

### Speed Regulation on/off

In CP.32 you can select whether the inverter operates open-loop or closed loop.

*Adjustment Range:* 0...1

*Resolution:* 1

*Factory setting:* 0

0 = open-loop (U/f-curve)

1 = closed-loop (field-oriented control)

During open-loop operation the torque limits, levels and displays do not have a function. All parameters, that access these values, either do not have a function or have a restricted function. This is described in the individual parameters.



**Caution! Only switch over when control release is open! Torque jumps may occur if not observed.**

CP33

### Boost

The voltage increase for the lower speed range is adjusted with the boost, which results in a higher torque in the lower range. **During closed-loop operation this parameter does not have a function!**

*Adjustment Range:* 0...25 %

*Resolution:* 0,1 %

*Factory setting:* 2 %

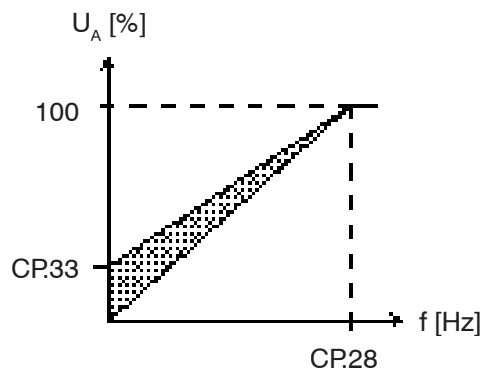

**When the motor is driven during continuous operation at a slow speed and the voltage is too high, the motor may overheat!**



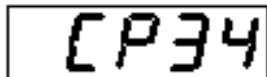

## Change Encoder 1 Rotation

Adjusts the direction of rotation of the encoder.

*Adjustment Range:* 0...1

*Resolution:* 1

*Factory setting:* 0

0 = track **not** exchanged

1 = track exchanged

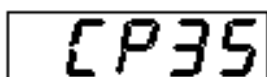

## Reaction to Limit Switch

This parameter determines the reaction of the drive, to terminal X2.3 (F) and/or X2.4 (R). These terminals can be programmed as software limit switches. The reaction of the drive is shown in the table below.

*Adjustment Range:* 0...6

*Resolution:* 1

*Factory setting:* 6

Value	Error / Status message	Response of the drive
0	<b>E.PrF</b> <b>E.Prr</b>	modulation immediately switched off <b>! To restart remove error and activate Reset !</b>
1	<b>A.PrF</b> <b>A.Prr</b>	quick stop / modulation switched off after speed 0 is reached <b>! To restart remove error and activate Reset !</b>
2	<b>A.PrF</b> <b>A.Prr</b>	quick stop / holding torque at speed 0 <b>! To restart remove error and activate Reset !</b>
3	<b>A.PrF</b> <b>A.Prr</b>	modulation immediately switched off <b>! Automatic restart</b> , when error is no longer present <b>!</b>
4	<b>A.PrF</b> <b>A.Prr</b>	quick stop / modulation switched off after speed 0 is reached <b>! Automatic restart</b> , when error is no longer present <b>!</b>
5	<b>A.PrF</b> <b>A.Prr</b>	quick stop / holding torque at speed 0 <b>! Automatic restart</b> , when error is no longer present <b>!</b>
6	<b>keine</b>	no effect on the drive <b>! Fault is ignored !</b>



**Quick stop**



deceleration at the torque limit (CP.9)

## 4. Parameter Description

**CP36**

### Aux Function

In CP.36 you can adjust on which parameter the 2nd analog input REF2 should work (X2.16 / X2.17). **During open-loop operation values 2; 3; 4 and 5 do not have a function!**

*Adjustment range:* 0...5  
*Resolution:* 1  
*Factory setting:* 0

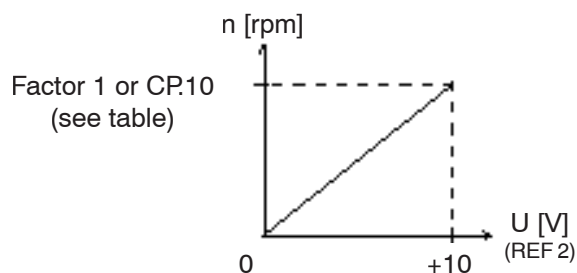

Value	Function Analog Input REF2
0	no function
1	adds to the setpoint (has no influence on the Jogging operation) 10 V = CP.10
2	works as a multiplier for parameter CP.12 (P-factor of the speed controller) 10 V = gain 1
3	works as a multiplier for parameter CP.13 (I-factor of the speed controller) 10 V = gain 1
4	works as a multiplier for parameter CP.12 + CP.13 (total gain of the speed cotnroller) 10 V = gain 1
5	works as a multiplier for parameter CP.9 (torque limit) 10 V = gain 1



In the table below the factory settings for the size-dependent parameter values are listed.

Unit size	CP.25 [ kW ] Rated motor power	CP.26 [ rpm ] Rated motor speed	CP.27 [ A ] Rated motor current	CP.28 [ Hz ] Rated motor frequency	CP.29 cos Phi Rated motor cos (Phi)	CP.30 [ V ] Rated motor voltage	[ Nm ] Rated motor torque	CP.9 [ Nm ] Maximum torque
07	0,55	1400	2,8	50	0,72	<b>230</b>	3,7	10,5
13	4	1435	15,3	50	0,78	<b>230</b>	26,6	68,5
14	5,5	1440	18,5	50	0,89	<b>230</b>	36,4	100,2
15	7,5	1440	26,0	50	0,84	<b>230</b>	49,2	148,9
10	1,5	1400	3,4	50	0,83	<b>400</b>	10,2	32,5
12	3,0	1435	6,7	50	0,79	<b>400</b>	19,9	53,9
13 - E	4	1435	8,8	50	0,78	<b>400</b>	26,6	69,9
13 - G	4	1435	8,8	50	0,78	<b>400</b>	26,6	59,0
14 - E	5,5	1440	10,5	50	0,89	<b>400</b>	36,4	103,5
14 - G	5,5	1440	10,5	50	0,89	<b>400</b>	36,4	88,0
15	7,5	1440	15,0	50	0,84	<b>400</b>	49,7	125,8
16	11	1440	21,5	50	0,85	<b>400</b>	72,9	175,2
17	15	1455	28,5	50	0,86	<b>400</b>	98,5	224,6
18	18,5	1455	35,0	50	0,86	<b>400</b>	121,4	268,4
19	22	1470	42,0	50	0,84	<b>400</b>	142,9	321,5
20	30	1465	55,5	50	0,85	<b>400</b>	195,5	411,4
21	37	1470	67,0	50	0,86	<b>400</b>	240,3	498,3
22	45	1470	81	50	0,86	<b>400</b>	292,3	646,3
23	55	1475	98,5	50	0,86	<b>400</b>	356,0	840,9

## 5. Drive-Mode

### 5. Drive-Mode

The Drive-Mode is a special operating mode in **KEB COMBIVERT**. It allows an easy manual start-up. To activate the Drive-Mode enter the respective password in **CP.0**.

**The passwords are found on page GB 43!**

#### 5.1 Adjustment Possibilities

- Stop / Start / Run
- Setpoint value
- Direction of rotation

#### 5.2 Condition

Control release must be activated (terminal X2.1)



When the functions rotation release (terminal X2.3 / X2.4) and analog torque control (terminal X2.16 / X2.17) are activated, they still don't have a function in the Drive-Mode.

#### 5.3 Display and Keyboard

Rotation Indicator

Interface control LED „flickers“ as soon as the inverter sends data

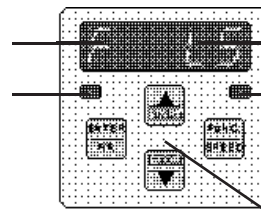

Displays Operating Mode / Actual speed / set speed

Operation / Error display  
No error: „LED on“  
Error: „LED blinks“

Operator Panel

#### 5.4 Setvalue Display / Setvalue presetting

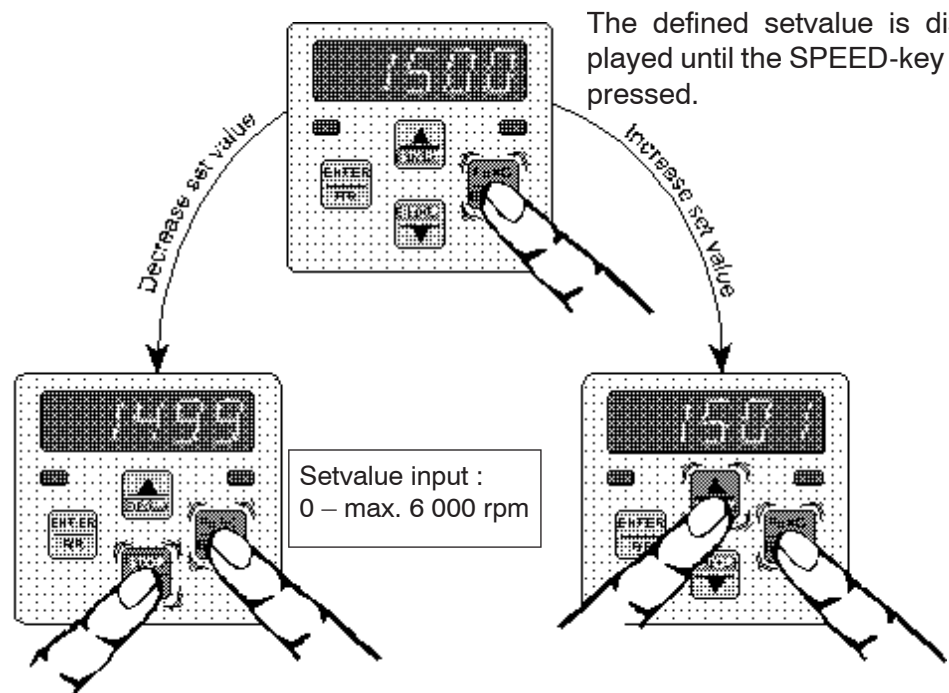

The defined setvalue is displayed until the SPEED-key is pressed.

Hold the SPEED-key pressed down and decrease the indicated setvalue with the STOP-key.

Hold the SPEED-key pressed down and increase the indicated setvalue with the START-key.

5.5 Rotation Presetting

Presetting possibilities: **F** = forward  
**r** = reverse

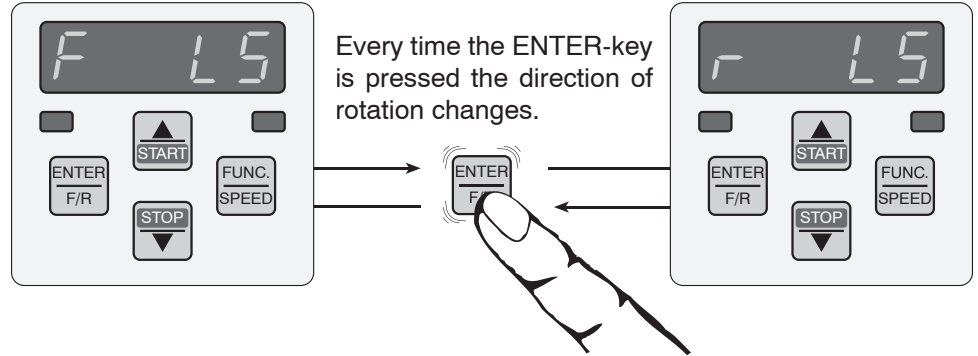



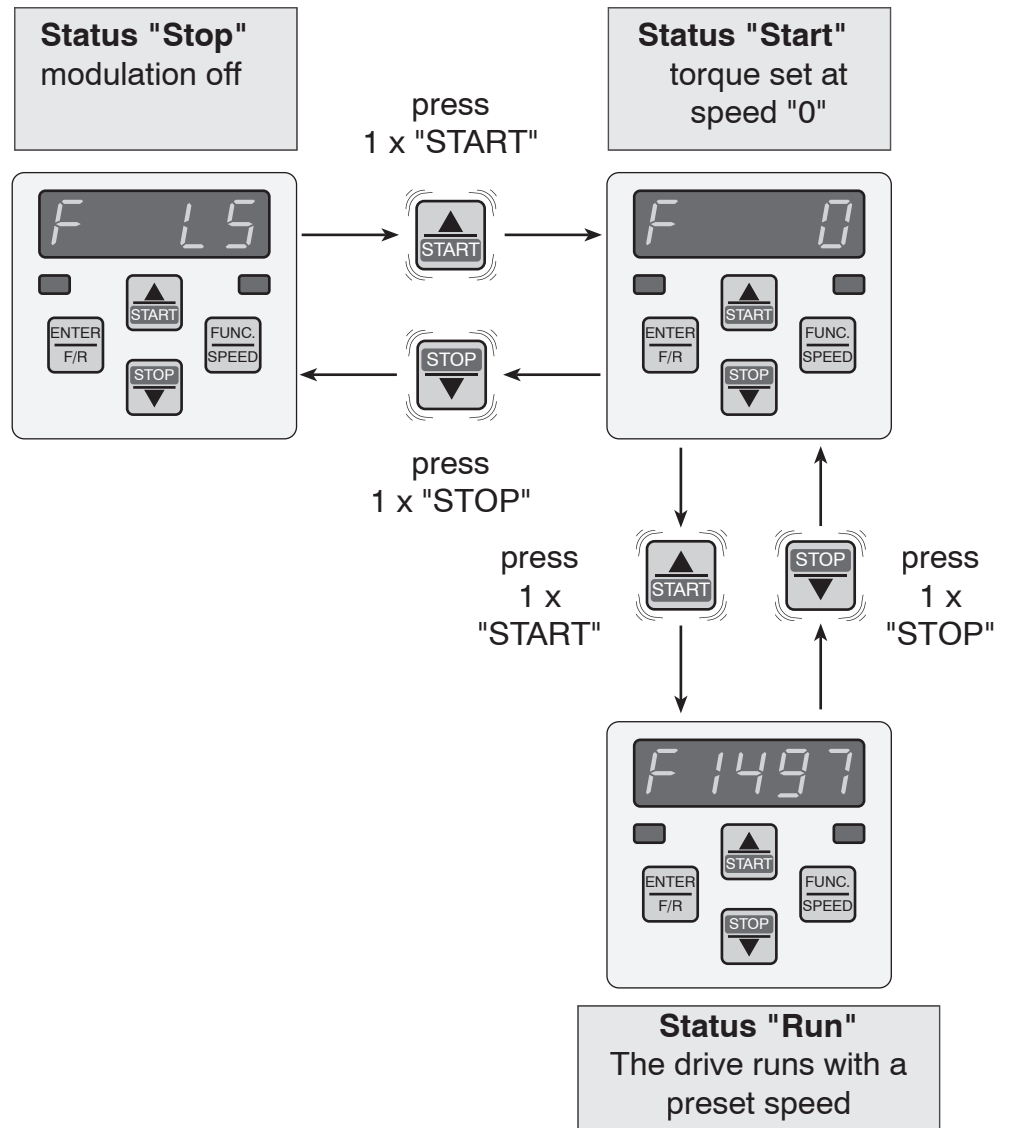



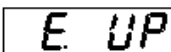
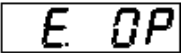
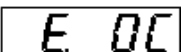
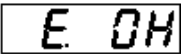
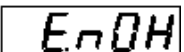
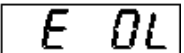

5.6 Start / Stop / RUN

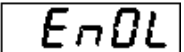
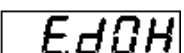
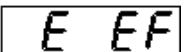

To change from the Drive-Mode to the CP-Mode, press the "FUNC." and "ENTER"- keys simultaneously and hold for at least 3 sec!  
! Only possible in status "Stop" !

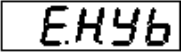
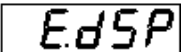
## 6. Fault Diagnosis

Display	Fault	Description
	<b>Underpotential</b>	Occurs when the dc-bus voltage drops below the permissible value.
	<b>Overpotential</b>	Occurs when the dc-bus voltage rises above the permissible value.
	<b>Overcurrent</b>	Occurs when the output current exceeds the permissible value.
	<b>Overheat</b>	Occurs when the maximal permissible heat sink temperature is exceeded. (see instruction manual part 2).
	<b>no Overheat</b>	The message E.nOH appears, when the overheating error is no longer present.
	<b>Overload</b>	The message E.OL occurs when an overload is present for longer than the permissible time.
	<b>Overload 2</b>	The message E.OL2 occurs at frequencies < 3Hz in dependence on the heat sink temperature.
	<b>no Overload</b>	The message E.nOL appears after the cooling phase. (see curves in the instruction manual part 2).
	<b>Drive Overheat</b>	Occurs 60 s after the temperature monitoring is triggered.
	<b>External Fault</b>	Occurs when parameter CP.15 = 0 the digital input I3 is activated.
	<b>Power Unit Code</b>	_____
	<b>Prohibited rotation forward</b>	Occurs when the rotation release on terminal X2.3 and/or X2.4 is not present and parameter CP.35 = 0.
	<b>Prohibited rotation reverse</b>	
	<b>Hybrid</b>	Speed measurement card missing or defective.
	<b>digital signal processor</b>	Processor - fault
	<b>Ladeshunt fault</b>	Occurs when the input voltage is too low after startup or the ladeshunt fault didn't switch. (Monitoring with ladeshunt relays not possible with all unit sizes).

Possible Cause	Fault Remedy
<ul style="list-style-type: none"> <li>- Input voltage too low or unstable</li> <li>- Voltage losses due to incorrect cabling</li> </ul>	<ul style="list-style-type: none"> <li>- Check voltage supply</li> <li>- Check input line</li> </ul>
<ul style="list-style-type: none"> <li>- Input voltage too high</li> <li>- Deceleration torque too high</li> </ul>	<ul style="list-style-type: none"> <li>- Check voltage supply</li> <li>- Connect braking resistor</li> </ul>
-Short-circuit or ground fault at the output	- Test motor lines for short-circuit or earth-fault
<ul style="list-style-type: none"> <li>- Insufficient cooling</li> <li>- Ambient temperature too high</li> <li>- Fan clogged</li> </ul>	<ul style="list-style-type: none"> <li>- Improve cooling</li> <li>- Upload inverter</li> </ul>
- Inverter overloaded	<ul style="list-style-type: none"> <li>- Upload motor</li> <li>- Reduce torque limit (Parameter CP.9)</li> </ul>
<ul style="list-style-type: none"> <li>- PTC - triggering (PTC = positive temperature coefficient)</li> <li>- PTC - line defective (PTC = positive temperature coefficient)</li> </ul>	<ul style="list-style-type: none"> <li>- Let motor cool down</li> <li>- Check PTC - line</li> </ul>
<ul style="list-style-type: none"> <li>- external entry fault</li> </ul> <p><b>! Only when Parameter CP.15 = 0 !</b></p>	- Remove external fault and press RESET
_____	- Fault correction only ex works!
<ul style="list-style-type: none"> <li>- Signal on terminal X2.3 and/or X2.4 missing</li> </ul> <p><b>! Only when Parameter CP.35 = 0 !</b></p>	- Check wiring at the inputs
_____	- Fault correction only ex works!
_____	- Fault correction only ex works!
<ul style="list-style-type: none"> <li>- Input voltage too low</li> <li>- Ladeshunt relay defective</li> </ul>	<ul style="list-style-type: none"> <li>- Check voltage supply</li> <li>- Fault correction only ex works!</li> </ul>

## 7. Startup

For the initial startup of KEB COMBIVERT F4-F do the following:

- |   |                          |   |
|---|--------------------------|---|
| 1. Switch off control release (terminal X2.1) | <input type="checkbox"/> | Inverter in status „noP“                |
| 2. Select controlled operation                | <input type="checkbox"/> | Parameter CS.23                         |
| 3. Enter motor data                           | <input type="checkbox"/> | Parameter CP.25...CP.30 see page GB 35) |
| 4. Activate Load motor dependent parameter    | <input type="checkbox"/> | Parameter CP.31                         |
| 5. Enter necessary boost                      | <input type="checkbox"/> | Parameter CP.33                         |
| 6. Enter encoder (inc/r)                      | <input type="checkbox"/> | Parameter CP.14                         |
| 7. OBserve cut-off frequency of encoder       | <input type="checkbox"/> | See page GB 13                          |
| 8. Startup in controlled operation            | <input type="checkbox"/> | See diagram below                       |

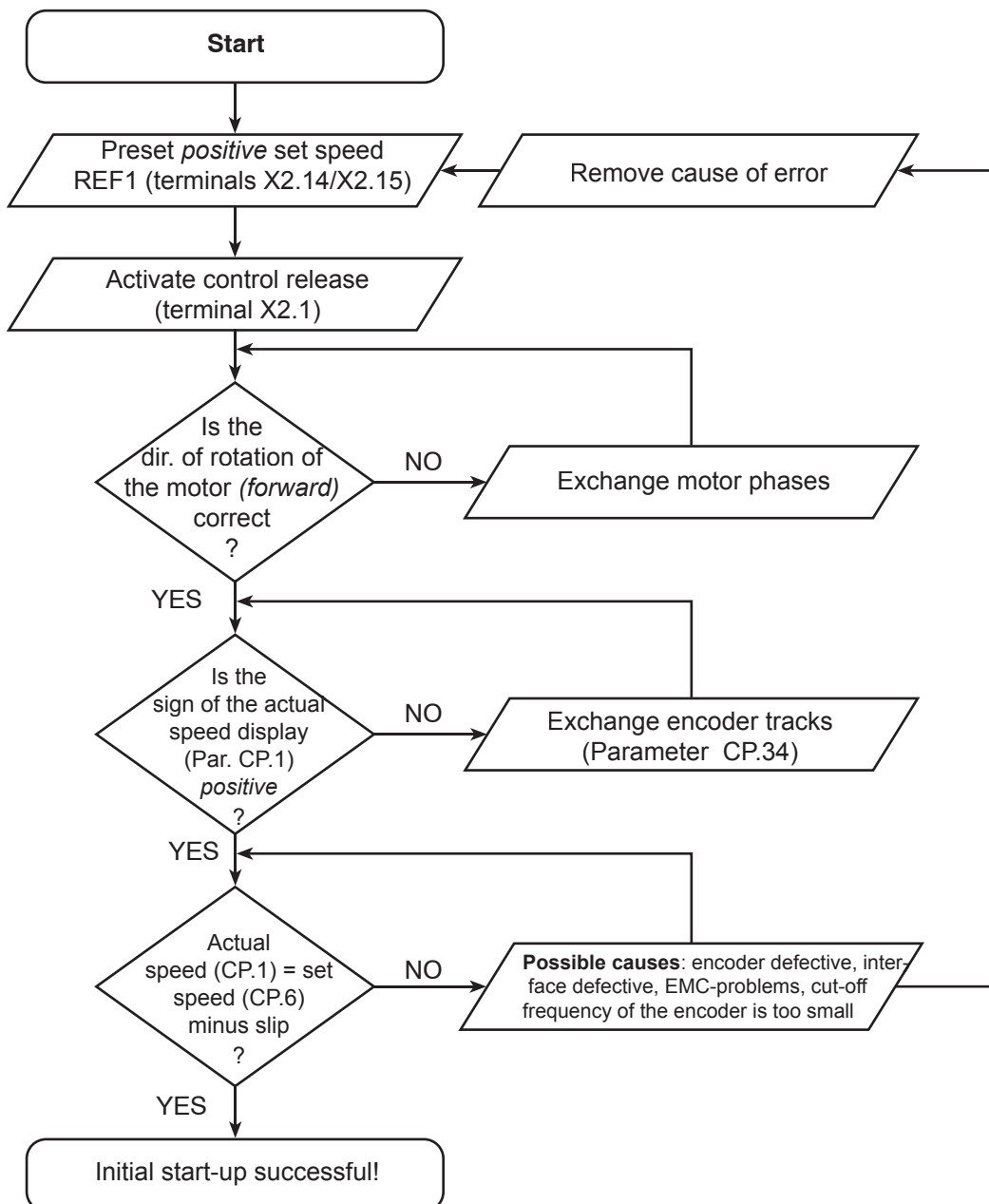



After the initial startup do the adjustments for closed-loop operation as follows:

1. Switch off control release (terminal X2.1)
  2. Select closed-loop operation
  3. Adjust speed controller
- Inverter in status "noP"  
 Parameter CP.32  
 See adjustment tips below

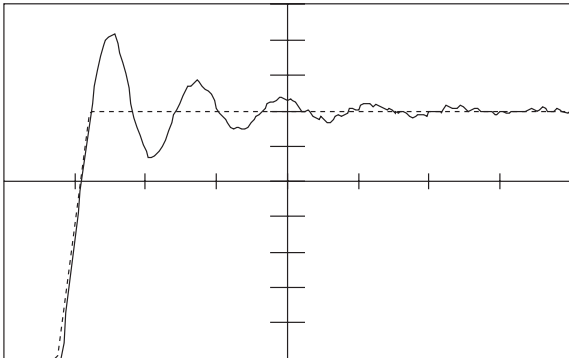

Problem: Very long transient process

Solution: Increase P-fraction (CP.12); eventually reduce I-fraction (CP.13)

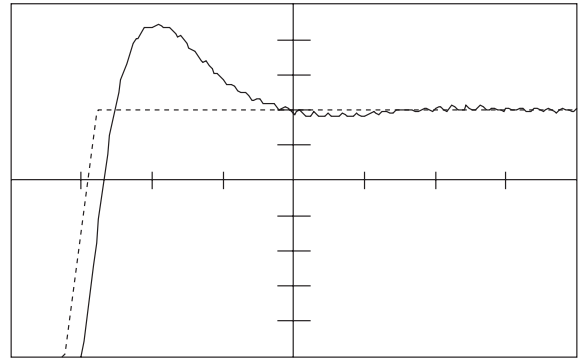

Problem: Speed overshoot too high

Solution: Increase P-fraction (CP.12); eventually reduce I-fraction (CP.13)

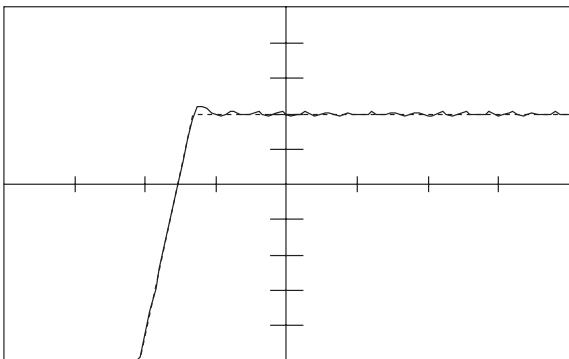

Problem: Sustained oscillation during constant run

Solution: Decrease P-fraction (CP.12)

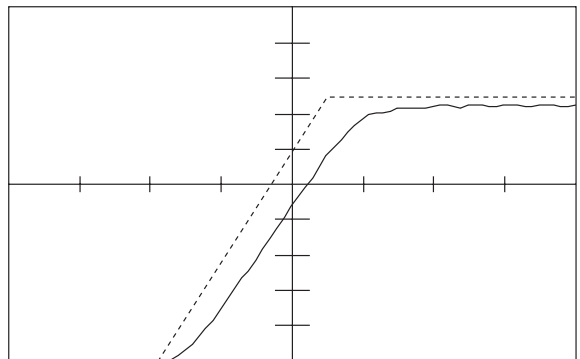

Problem: Transient too slow / remaining system deviation

Solution: Increase I-fraction (CP.13)

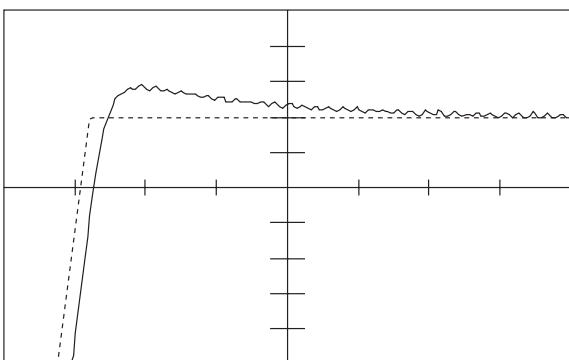

Problem: Overshoot too long

Solution: Increase I-fraction (CP.13)

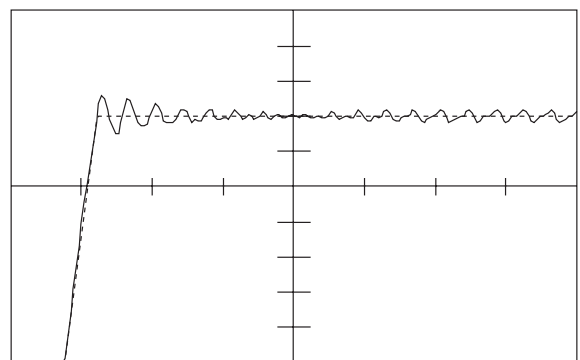

Problem: Sustained oscillation with high amplitude

Solution: Reduce I-fraction (CP.13)

## 8. Short Manual

Parameter number	Name	Adjustment range	Resolution	Customer setting
CP.0	Password input	0...9999	1	—
CP.1	Actual speed display	—	0,5 rpm	—
CP.2	Status display	—	—	—
CP.3	Apparent motor current	—	0,1 A	—
CP.4	Max. apparent motor current	—	0,1 A	—
CP.5	Actual torque display	—	0,1 Nm	—
CP.6	Speed reference display	—	0,5 rpm	—
CP.7	Acceleration time	0...320 s	0,01 s	_____ s
CP.8	Deceleration time	0...320 s	0,01 s	_____ s
CP.9	Torque limit	0...5 x M <sub>N</sub> Nm	0,1 Nm	_____ Nm
CP.10	Maximum setpoint speed	0...6000 rpm	0,5 rpm	_____ rpm
CP.11	Jogging speed	0...6000 rpm	0,5 rpm	_____ rpm
CP.12	P-factor speed controller	0...65535	1	_____
CP.13	I-factor speed controller	0...65535	1	_____
CP.14	Encoder 1 (inc/r)	256...10000	1	_____
CP.15	Behaviour at external fault	0...6	1	_____
CP.16	Offset REF 1	-100...+100 %	0,1 %	_____ %
CP.17	Zero point hysteresis REF 1	0...10 %	0,1 %	_____ %
CP.18	Function output A1	0...6	1	_____
CP.19	Gain output A1	-20...+20	0,01	_____
CP.20	Gain output A2	-20...+20	0,01	_____
CP.21	Output condition OUT D1	0...20	1	_____
CP.22	Output condition OUT D2	0...20	1	_____
CP.23	Torque level OUT D1	0...50 Nm	0,1 Nm	_____ Nm
CP.24	Torque level OUT D2	0...9999,5 rpm	0,5 rpm	_____ rpm
CP.25	Rated motor power	0,01...75 kW	0,01 kW	_____ kW
CP.26	Rated motor speed	100...6000 rpm	1 rpm	_____ rpm
CP.27	Rated motor current	0,1...50 A	0,1 A	_____ A
CP.28	Rated motor frequency	20...300 Hz	1 Hz	_____ Hz
CP.29	Rated motor cos (Phi)	0,05...1	0,01	_____
CP.30	Rated motor voltage	100...400 V	1 V	_____ V
CP.31	Load motor dependent parameter	0...2	1	_____
CP.32	Speed regulation on/off	0...1	1	_____
CP.33	Boost	0...25 %	0,1 %	_____ %
CP.34	Change encoder 1 rotation	0...1	1	_____
CP.35	Reaction to limit switch	0...6	1	_____
CP.36	AUX function	0...5	1	_____

Enter Password

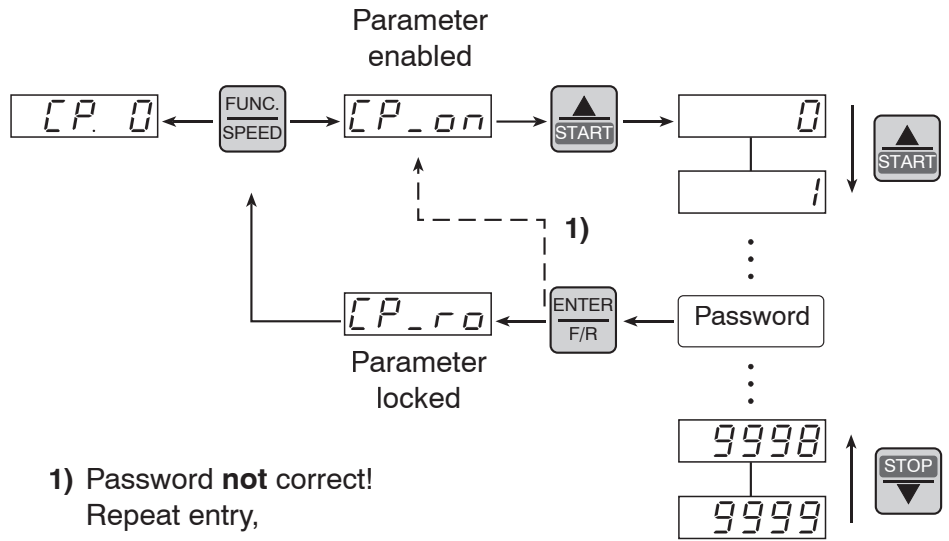

1) Password **not** correct!  
Repeat entry,

**100**  
Read Only

**200**  
Read/Write

**500**  
Drive-Mode





**Karl E. Brinkmann GmbH**  
Försterweg 36-38 • D-32683 Barntrup  
fon: +49 5263 401-0 • fax: +49 5263 401-116  
net: [www.keb.de](http://www.keb.de) • mail: [info@keb.de](mailto:info@keb.de)

**KEB Antriebstechnik GmbH & Co. KG**  
Wildbacher Str. 5 • D-08289 Schneeberg  
fon: +49 3772 67-0 • fax: +49 3772 67-281  
mail: [info@keb-combidrive.de](mailto:info@keb-combidrive.de)

**KEB Antriebstechnik Austria GmbH**  
Ritzstraße 8 • A-4614 Marchtrenk  
fon: +43 7243 53586-0 • fax: +43 7243 53586-21  
net: [www.keb.at](http://www.keb.at) • mail: [info@keb.at](mailto:info@keb.at)

**KEB Antriebstechnik**  
Herenveld 2 • B-9500 Geraadsbergen  
fon: +32 5443 7860 • fax: +32 5443 7898  
mail: [vb.belgien@keb.de](mailto:vb.belgien@keb.de)

**KEB Power Transmission Technology (Shanghai) Co. Ltd – Office Room 401**  
No. 665 North Songwei Road (New Husong Road),  
Songjiang District, CHN-201613 Shanghai, P.R. China  
fon: +86 21 51095995 • fax: +86 21 54450115  
net: [www.keb.cn](http://www.keb.cn) • mail: [info@keb.cn](mailto:info@keb.cn)

**KEB Antriebstechnik Austria GmbH**  
Organizační složka  
K. Weise 1675/5 • CZ-370 04 České Budějovice  
fon: +420 387 699 111 • fax: +420 387 699 119  
net: [www.keb.cz](http://www.keb.cz) • mail: [info.keb@seznam.cz](mailto:info.keb@seznam.cz)

**KEB España**  
C/ Mitjer, Nave 8 - Pol. Ind. LA MASIA  
E-08798 Sant Cugat Sesgarrigues (Barcelona)  
fon: +34 93 897 0268 • fax: +34 93 899 2035  
mail: [vb.espana@keb.de](mailto:vb.espana@keb.de)

**Société Française KEB**  
Z.I. de la Croix St. Nicolas • 14, rue Gustave Eiffel  
F-94510 LA QUEUE EN BRIE  
fon: +33 1 49620101 • fax: +33 1 45767495  
net: [www.keb.fr](http://www.keb.fr) • mail: [info@keb.fr](mailto:info@keb.fr)

**KEB (UK) Ltd.**  
6 Chieftain Business Park, Morris Close  
Park Farm, Wellingborough GB-Northants, NN8 6 XF  
fon: +44 1933 402220 • fax: +44 1933 400724  
net: [www.keb-uk.co.uk](http://www.keb-uk.co.uk) • mail: [info@keb-uk.co.uk](mailto:info@keb-uk.co.uk)

**KEB Italia S.r.l.**  
Via Newton, 2 • I-20019 Settimo Milanese (Milano)  
fon: +39 02 33535311 • fax: +39 02 33500790  
net: [www.keb.it](http://www.keb.it) • mail: [kebitalia@keb.it](mailto:kebitalia@keb.it)

**KEB - YAMAKYU Ltd.**  
15-16, 2-Chome, Takanawa Minato-ku  
J-Tokyo 108-0074  
fon: +81 33 445-8515 • fax: +81 33 445-8215  
mail: [info@keb.jp](mailto:info@keb.jp)

**KEB Korea Seoul**  
Room 1709, 415 Missy 2000  
725 Su Seo Dong, Gang Nam Gu  
ROK-135-757 Seoul/South Korea  
fon: +82 2 6253 6771 • fax: +82 2 6253 6770  
mail: [vb.korea@keb.de](mailto:vb.korea@keb.de)

**KEB RUS Ltd.**  
Ferganskaya str. 8/2  
RUS-109444 Moscow  
fon: +007 499 972 3162 • fax: +007 499 978 9573  
mail: [info@keb.ru](mailto:info@keb.ru)

**KEB Sverige**  
Box 265 (Bergavägen 19)  
S-43093 Hälsö  
fon: +46 31 961520 • fax: +46 31 961124  
mail: [vb.schweden@keb.de](mailto:vb.schweden@keb.de)

**KEB America, Inc.**  
5100 Valley Industrial Blvd. South  
USA-Shakopee, MN 55379  
fon: +1 952 224-1400 • fax: +1 952 224-1499  
net: [www.kebamerica.com](http://www.kebamerica.com) • mail: [info@kebamerica.com](mailto:info@kebamerica.com)